

NID9N05CL, NID9N05ACL

Power MOSFET

9.0 A, 52 V, N-Channel, Logic Level, Clamped MOSFET w/ESD Protection in a DPAK Package



ON Semiconductor®

<http://onsemi.com>

Benefits

- High Energy Capability for Inductive Loads
- Low Switching Noise Generation

Features

- Diode Clamp Between Gate and Source
- ESD Protection – HBM 5000 V
- Active Over-Voltage Gate to Drain Clamp
- Scalable to Lower or Higher $R_{DS(on)}$
- Internal Series Gate Resistance
- AEC-Q101 Qualified and PPAP Capable
- These Devices are Pb-Free and are RoHS Compliant

Applications

- Automotive and Industrial Markets:
Solenoid Drivers, Lamp Drivers, Small Motor Drivers

MAXIMUM RATINGS ($T_J = 25^\circ\text{C}$ unless otherwise noted)

Rating	Symbol	Value	Unit
Drain-to-Source Voltage Internally Clamped	V_{DSS}	52-59	V
Gate-to-Source Voltage – Continuous	V_{GS}	± 15	V
Drain Current – Continuous @ $T_A = 25^\circ\text{C}$ – Single Pulse ($t_p = 10 \mu\text{s}$)	I_D I_{DM}	9.0 35	A
Total Power Dissipation @ $T_A = 25^\circ\text{C}$	P_D	1.74	W
Operating and Storage Temperature Range	T_J, T_{stg}	-55 to 175	$^\circ\text{C}$
Single Pulse Drain-to-Source Avalanche Energy – Starting $T_J = 125^\circ\text{C}$ ($V_{DD} = 50 \text{ V}$, $I_{D(pk)} = 1.5 \text{ A}$, $V_{GS} = 10 \text{ V}$, $R_G = 25 \Omega$)	E_{AS}	160	mJ
Thermal Resistance, Junction-to-Case Junction-to-Ambient (Note 1) Junction-to-Ambient (Note 2)	$R_{\theta JC}$ $R_{\theta JA}$ $R_{\theta JA}$	5.2 72 100	$^\circ\text{C/W}$
Maximum Lead Temperature for Soldering Purposes, 1/8" from Case for 10 seconds	T_L	260	$^\circ\text{C}$

Stresses exceeding Maximum Ratings may damage the device. Maximum Ratings are stress ratings only. Functional operation above the Recommended Operating Conditions is not implied. Extended exposure to stresses above the Recommended Operating Conditions may affect device reliability.

1. When surface mounted to a FR4 board using 1" pad size, (Cu area 1.127 in²).
2. When surface mounted to a FR4 board using minimum recommended pad size, (Cu area 0.412 in²).

V_{DSS} (Clamped)	$R_{DS(on)}$ TYP	I_D MAX (Limited)
52 V	90 m Ω	9.0 A

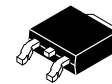
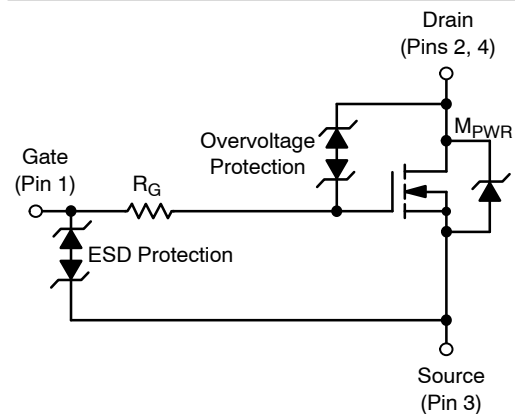

DPAK
CASE 369C
STYLE 2

MARKING DIAGRAM

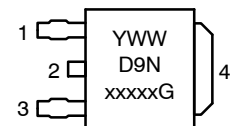

Y	= Year	1	= Gate
WW	= Work Week	2	= Drain
xxxxx	= 05CL or 05ACL	3	= Source
G	= Pb-Free Package	4	= Drain

ORDERING INFORMATION

Device	Package	Shipping†
NID9N05CLG	DPAK (Pb-Free)	75 Units/Rail
NID9N05CLT4G	DPAK (Pb-Free)	2500/Tape & Reel
NID9N05ACL4G		

†For information on tape and reel specifications, including part orientation and tape sizes, please refer to our Tape and Reel Packaging Specification Brochure, BRD8011/D.

NID9N05CL, NID9N05ACL

ELECTRICAL CHARACTERISTICS (T_J = 25°C unless otherwise noted)

Characteristic	Symbol	Min	Typ	Max	Unit
----------------	--------	-----	-----	-----	------

OFF CHARACTERISTICS

Drain-to-Source Breakdown Voltage (Note 3) (V _{GS} = 0 V, I _D = 1.0 mA, T _J = 25°C) (V _{GS} = 0 V, I _D = 1.0 mA, T _J = -40°C to 125°C) Temperature Coefficient (Negative)	V _{(BR)DSS}	52 50.8 -	55 54 -10	59 59.5 -	V V mV/°C
Zero Gate Voltage Drain Current (V _{DS} = 40 V, V _{GS} = 0 V) (V _{DS} = 40 V, V _{GS} = 0 V, T _J = 125°C)	I _{DSS}	- -	- -	10 25	μA
Gate-Body Leakage Current (V _{GS} = ±8 V, V _{DS} = 0 V) (V _{GS} = ±14 V, V _{DS} = 0 V)	I _{GSS}	- -	- ±22	±10 -	μA

ON CHARACTERISTICS (Note 3)

Gate Threshold Voltage (Note 3) (V _{DS} = V _{GS} , I _D = 100 μA) Threshold Temperature Coefficient (Negative)	V _{GS(th)}	1.3 -	1.75 -4.5	2.5 -	V mV/°C
Static Drain-to-Source On-Resistance (Note 3) (V _{GS} = 4.0 V, I _D = 1.5 A) (V _{GS} = 3.5 V, I _D = 0.6 A) (V _{GS} = 3.0 V, I _D = 0.2 A) (V _{GS} = 12 V, I _D = 9.0 A) (V _{GS} = 12 V, I _D = 12 A)	R _{DS(on)}	- - - 70 67	153 175 - 90 95	181 364 1210 - -	mΩ
Forward Transconductance (Note 3) (V _{DS} = 15 V, I _D = 9.0 A)	g _{FS}	-	24	-	Mhos

DYNAMIC CHARACTERISTICS

Input Capacitance	(V _{DS} = 40 V, V _{GS} = 0 V, f = 10 kHz)	C _{iss}	-	155	250	pF
Output Capacitance		C _{oss}	-	60	100	
Transfer Capacitance		C _{rss}	-	25	40	
Input Capacitance	(V _{DS} = 25 V, V _{GS} = 0 V, f = 10 kHz)	C _{iss}	-	175	-	pF
Output Capacitance		C _{oss}	-	70	-	
Transfer Capacitance		C _{rss}	-	30	-	

3. Pulse Test: Pulse Width ≤ 300 μs, Duty Cycle ≤ 2%.
4. Switching characteristics are independent of operating junction temperatures.

NID9N05CL, NID9N05ACL

ELECTRICAL CHARACTERISTICS (T_J = 25°C unless otherwise noted)

Characteristic	Symbol	Min	Typ	Max	Unit	
SWITCHING CHARACTERISTICS (Note 4)						
Turn-On Delay Time	$(V_{GS} = 10\text{ V}, V_{DD} = 40\text{ V}, I_D = 9.0\text{ A}, R_G = 9.0\ \Omega)$	$t_{d(on)}$	-	130	200	ns
Rise Time		t_r	-	500	750	
Turn-Off Delay Time		$t_{d(off)}$	-	1300	2000	
Fall Time		t_f	-	1150	1850	
Turn-On Delay Time	$(V_{GS} = 10\text{ V}, V_{DD} = 15\text{ V}, I_D = 1.5\text{ A}, R_G = 2\text{ k}\Omega)$	$t_{d(on)}$	-	200	-	ns
Rise Time		t_r	-	500	-	
Turn-Off Delay Time		$t_{d(off)}$	-	2500	-	
Fall Time		t_f	-	1800	-	
Turn-On Delay Time	$(V_{GS} = 10\text{ V}, V_{DD} = 15\text{ V}, I_D = 1.5\text{ A}, R_G = 50\ \Omega)$	$t_{d(on)}$	-	120	-	ns
Rise Time		t_r	-	275	-	
Turn-Off Delay Time		$t_{d(off)}$	-	1600	-	
Fall Time		t_f	-	1100	-	
Gate Charge	$(V_{GS} = 4.5\text{ V}, V_{DS} = 40\text{ V}, I_D = 9.0\text{ A})$ (Note 3)	Q_T	-	4.5	7.0	nC
		Q_1	-	1.2	-	
		Q_2	-	2.7	-	
Gate Charge	$(V_{GS} = 4.5\text{ V}, V_{DS} = 15\text{ V}, I_D = 1.5\text{ A})$ (Note 3)	Q_T	-	3.6	-	nC
		Q_1	-	1.0	-	
		Q_2	-	2.0	-	

SOURCE-DRAIN DIODE CHARACTERISTICS

Forward On-Voltage	$(I_S = 4.5\text{ A}, V_{GS} = 0\text{ V})$ (Note 3) $(I_S = 4.0\text{ A}, V_{GS} = 0\text{ V})$ $(I_S = 4.5\text{ A}, V_{GS} = 0\text{ V}, T_J = 125^\circ\text{C})$	V_{SD}	-	0.86 0.845 0.725	1.2 -	V
Reverse Recovery Time	$(I_S = 4.5\text{ A}, V_{GS} = 0\text{ V}, di_S/dt = 100\text{ A}/\mu\text{s})$ (Note 3)	t_{rr}	-	700	-	ns
		t_a	-	200	-	
		t_b	-	500	-	
Reverse Recovery Stored Charge		Q_{RR}	-	6.5	-	μC

ESD CHARACTERISTICS

Electro-Static Discharge Capability	Human Body Model (HBM)	ESD	5000	-	-	V
	Machine Model (MM)		500	-	-	

3. Pulse Test: Pulse Width $\leq 300\ \mu\text{s}$, Duty Cycle $\leq 2\%$.
4. Switching characteristics are independent of operating junction temperatures.

NID9N05CL, NID9N05ACL

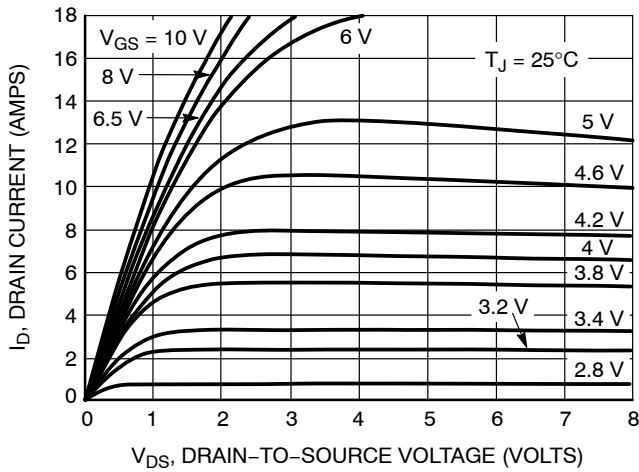

Figure 1. On-Region Characteristics

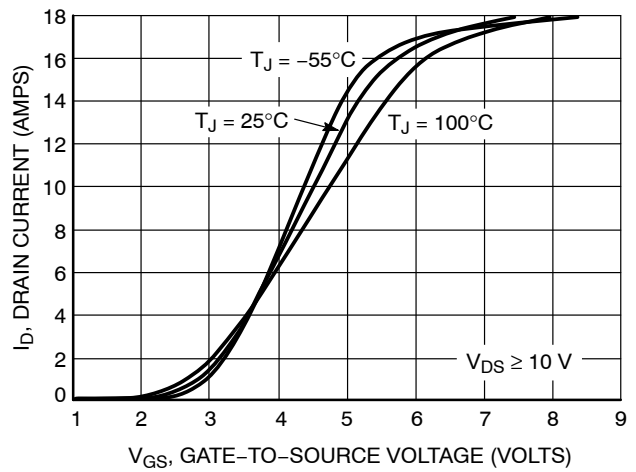

Figure 2. Transfer Characteristics

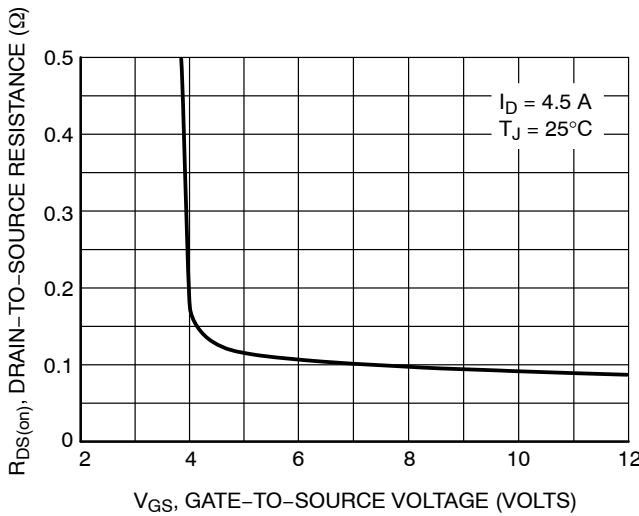

Figure 3. On-Resistance versus Gate-to-Source Voltage

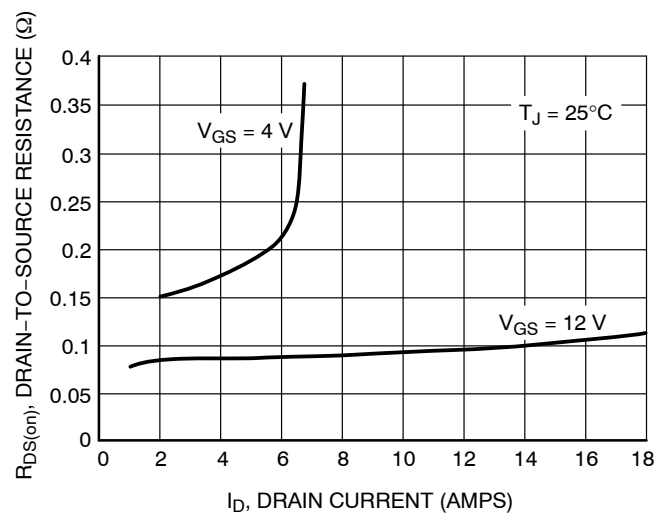

Figure 4. On-Resistance versus Drain Current and Gate Voltage

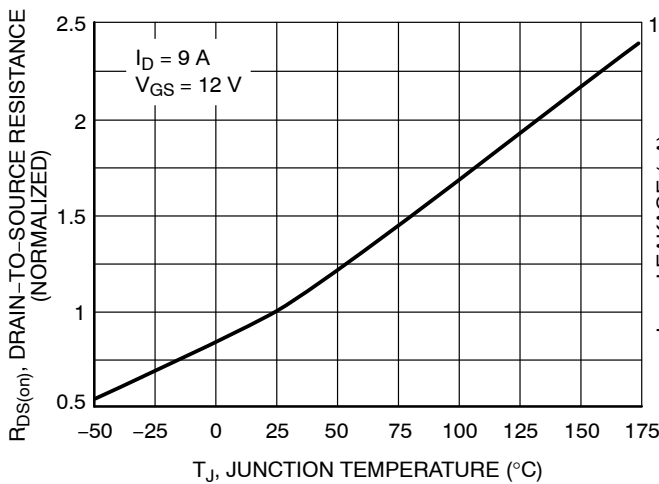

Figure 5. On-Resistance Variation with Temperature

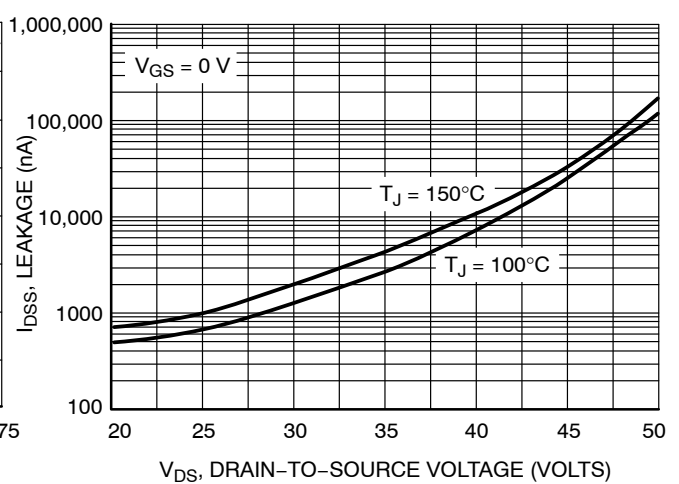

Figure 6. Drain-to-Source Leakage Current versus Voltage

NID9N05CL, NID9N05ACL

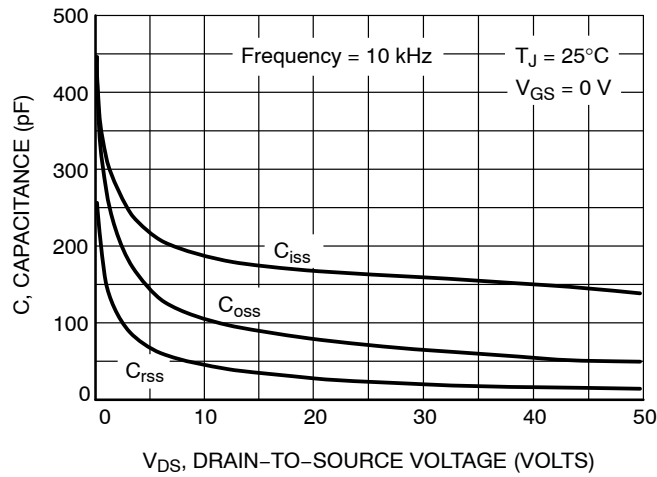

Figure 7. Capacitance Variation

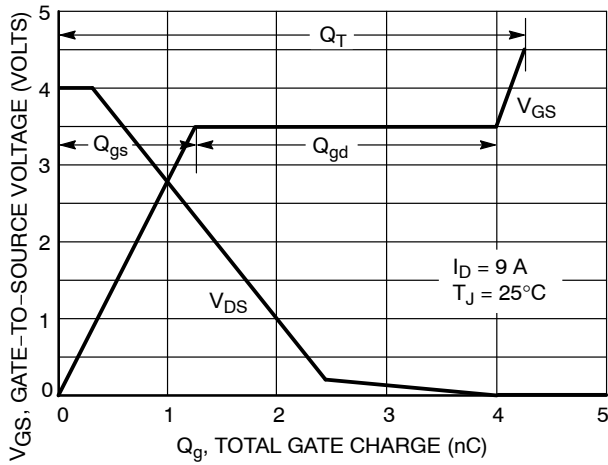

Figure 8. Gate-To-Source and Drain-To-Source Voltage versus Total Charge

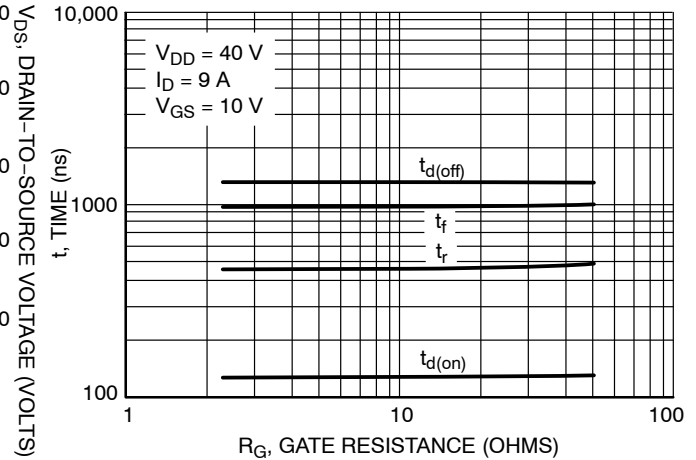

Figure 9. Resistive Switching Time Variation versus Gate Resistance

DRAIN-TO-SOURCE DIODE CHARACTERISTICS

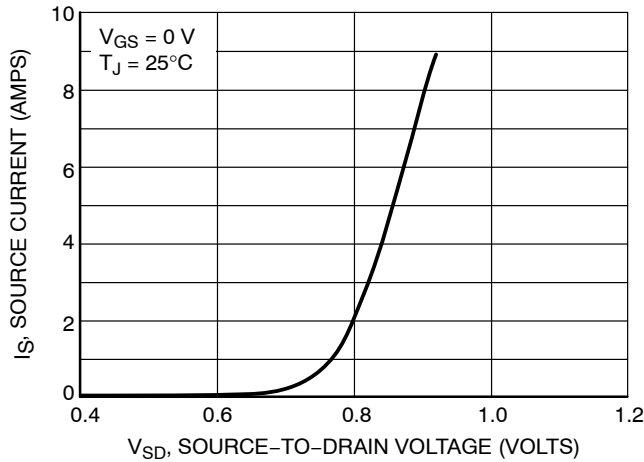

Figure 10. Diode Forward Voltage versus Current

NID9N05CL, NID9N05ACL

SAFE OPERATING AREA

The Forward Biased Safe Operating Area curves define the maximum simultaneous drain-to-source voltage and drain current that a transistor can handle safely when it is forward biased. Curves are based upon maximum peak junction temperature and a case temperature (T_C) of 25°C. Peak repetitive pulsed power limits are determined by using the thermal response data in conjunction with the procedures discussed in AN569, "Transient Thermal Resistance – General Data and Its Use."

Switching between the off-state and the on-state may traverse any load line provided neither rated peak current (I_{DM}) nor rated voltage (V_{DSS}) is exceeded and the transition time (t_r, t_f) do not exceed 10 μ s. In addition the total power averaged over a complete switching cycle must not exceed $(T_{J(MAX)} - T_C)/(R_{\theta JC})$.

A Power MOSFET designated E-FET can be safely used in switching circuits with unclamped inductive loads. For

reliable operation, the stored energy from circuit inductance dissipated in the transistor while in avalanche must be less than the rated limit and adjusted for operating conditions differing from those specified. Although industry practice is to rate in terms of energy, avalanche energy capability is not a constant. The energy rating decreases non-linearly with an increase of peak current in avalanche and peak junction temperature.

Although many E-FETs can withstand the stress of drain-to-source avalanche at currents up to rated pulsed current (I_{DM}), the energy rating is specified at rated continuous current (I_D), in accordance with industry custom. The energy rating must be derated for temperature as shown in the accompanying graph (Figure 12). Maximum energy at currents below rated continuous I_D can safely be assumed to equal the values indicated.

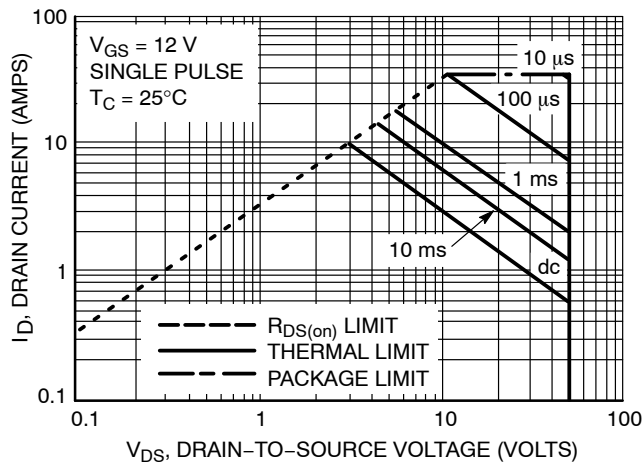

Figure 11. Maximum Rated Forward Biased Safe Operating Area

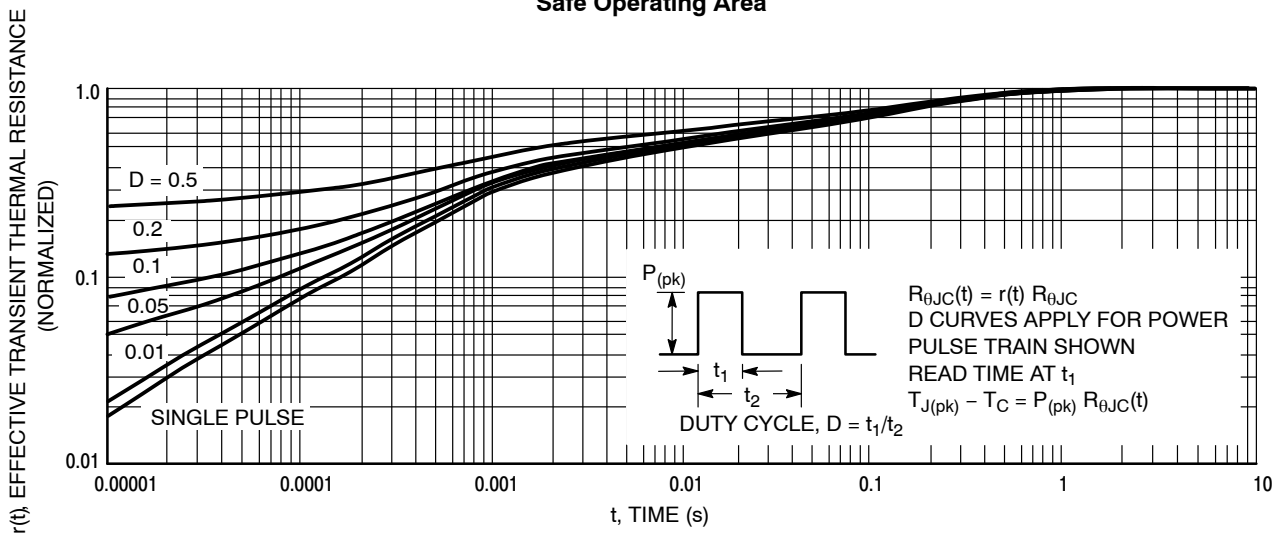
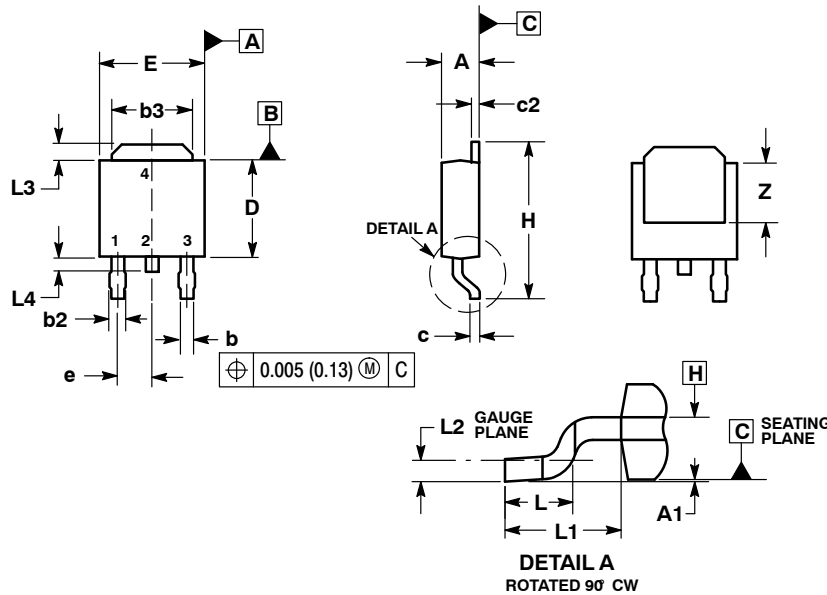

Figure 12. Thermal Response

NID9N05CL, NID9N05ACL

PACKAGE DIMENSIONS

DPAK (SINGLE GAUGE) CASE 369C ISSUE D



NOTES:

1. DIMENSIONING AND TOLERANCING PER ASME Y14.5M, 1994.
2. CONTROLLING DIMENSION: INCHES.
3. THERMAL PAD CONTOUR OPTIONAL WITHIN DIMENSIONS b3, L3 and Z.
4. DIMENSIONS D AND E DO NOT INCLUDE MOLD FLASH, PROTRUSIONS, OR BURRS. MOLD FLASH, PROTRUSIONS, OR GATE BURRS SHALL NOT EXCEED 0.006 INCHES PER SIDE.
5. DIMENSIONS D AND E ARE DETERMINED AT THE OUTERMOST EXTREMES OF THE PLASTIC BODY.
6. DATUMS A AND B ARE DETERMINED AT DATUM PLANE H.

DIM	INCHES		MILLIMETERS	
	MIN	MAX	MIN	MAX
A	0.086	0.094	2.18	2.38
A1	0.000	0.005	0.00	0.13
b	0.025	0.035	0.63	0.89
b2	0.030	0.045	0.76	1.14
b3	0.180	0.215	4.57	5.46
c	0.018	0.024	0.46	0.61
c2	0.018	0.024	0.46	0.61
D	0.235	0.245	5.97	6.22
E	0.250	0.265	6.35	6.73
e	0.090 BSC		2.29 BSC	
H	0.370	0.410	9.40	10.41
L	0.055	0.070	1.40	1.78
L1	0.108 REF		2.74 REF	
L2	0.020 BSC		0.51 BSC	
L3	0.035	0.050	0.89	1.27
L4	---	0.040	---	1.01
Z	0.155	---	3.93	---

STYLE 2:

1. GATE
2. DRAIN
3. SOURCE
4. DRAIN

SOLDERING FOOTPRINT*

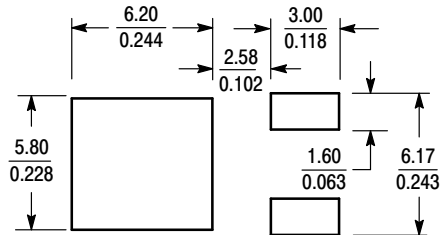

SCALE 3:1 $\left(\frac{\text{mm}}{\text{inches}}\right)$

*For additional information on our Pb-Free strategy and soldering details, please download the ON Semiconductor Soldering and Mounting Techniques Reference Manual, SOLDERRM/D.

ON Semiconductor and are registered trademarks of Semiconductor Components Industries, LLC (SCILLC). SCILLC reserves the right to make changes without further notice to any products herein. SCILLC makes no warranty, representation or guarantee regarding the suitability of its products for any particular purpose, nor does SCILLC assume any liability arising out of the application or use of any product or circuit, and specifically disclaims any and all liability, including without limitation special, consequential or incidental damages. "Typical" parameters which may be provided in SCILLC data sheets and/or specifications can and do vary in different applications and actual performance may vary over time. All operating parameters, including "Typicals" must be validated for each customer application by customer's technical experts. SCILLC does not convey any license under its patent rights nor the rights of others. SCILLC products are not designed, intended, or authorized for use as components in systems intended for surgical implant into the body, or other applications intended to support or sustain life, or for any other application in which the failure of the SCILLC product could create a situation where personal injury or death may occur. Should Buyer purchase or use SCILLC products for any such unintended or unauthorized application, Buyer shall indemnify and hold SCILLC and its officers, employees, subsidiaries, affiliates, and distributors harmless against all claims, costs, damages, and expenses, and reasonable attorney fees arising out of, directly or indirectly, any claim of personal injury or death associated with such unintended or unauthorized use, even if such claim alleges that SCILLC was negligent regarding the design or manufacture of the part. SCILLC is an Equal Opportunity/Affirmative Action Employer. This literature is subject to all applicable copyright laws and is not for resale in any manner.

PUBLICATION ORDERING INFORMATION

LITERATURE FULFILLMENT:

Literature Distribution Center for ON Semiconductor
P.O. Box 5163, Denver, Colorado 80217 USA
Phone: 303-675-2175 or 800-344-3860 Toll Free USA/Canada
Fax: 303-675-2176 or 800-344-3867 Toll Free USA/Canada
Email: orderlit@onsemi.com

N. American Technical Support: 800-282-9855 Toll Free USA/Canada
Europe, Middle East and Africa Technical Support:
Phone: 421 33 790 2910
Japan Customer Focus Center
Phone: 81-3-5817-1050

ON Semiconductor Website: www.onsemi.com

Order Literature: <http://www.onsemi.com/orderlit>

For additional information, please contact your local Sales Representative